



*Jura*<sup>®</sup>  
CAPRESSO

## Impressa J5

Fully Automatic  
Coffee & Espresso Center  
with Clearyl Water Care System

---

Operating Instructions  
and Warranty

---

Customer Service 1-800-220-5701

# IMPORTANT SAFEGUARDS

When using electrical appliances, basic safety precautions should always be followed, including the following:

1. Read all instructions.
2. Do not touch hot surfaces. Use handles or knobs.
3. To protect against fire, electric shock and personal injury, do not immerse cord, plugs or appliance in water or other liquids.
4. Close supervision is necessary when any appliance is used by or near children.
5. Unplug from outlet when not in use and before cleaning. Allow it to cool before putting on or taking off parts, and before cleaning the appliance.
6. Do not operate any appliance with a damaged cord or plug or after the appliance malfunctions, or has been damaged in any manner. Return appliance to the nearest authorized service facility for examination, repair or adjustment.
7. The use of accessory attachments not recommended by the appliance manufacturer may result in fire, electric shock, or personal injury.
8. Do not use outdoors.
9. Do not let the cord hang over the edge of a table or counter, or touch hot surfaces.
10. Do not place on or near a hot gas or electric burner, or in a heated oven.
11. Always attach plug to appliance first, then plug cord into

wall outlet. To disconnect, turn any control to "off" then remove plug from wall outlet.

12. Do not use appliance for other than intended use.
13. Use extreme caution when disposing hot steam.
14. For household use only.

## SAVE THESE INSTRUCTIONS SPECIAL CORD SET INSTRUCTIONS

Regarding your cord set:

- A. A short power-supply cord (or detachable power-supply cord) is to be provided to reduce risks resulting from becoming entangled in or tripping over a longer cord.
- B. Longer detachable power-supply or extension cords are available and may be used if care is exercised in their use.
- C. If a long detachable power-supply cord or extension cord is used,
  - 1) The marked electrical rating of the detachable power-supply cord or extension cord should be at least as great as the electrical rating of the appliance,
  - 2) If the appliance is of the grounded type, the extension cord should be a rounding type 3-wire cord, and
  - 3) The longer cord should be arranged so that it will not drape over the counter-top or table-top where it can be pulled on by children or tripped over.

**Notice:** Your Impresa J5 has a 3-prong grounded plug. To reduce the risk of electrical shock this plug will fit in an outlet only one way. If the plug does not fit in the outlet contact a qualified electrician. DO NOT modify the plug in any way.

## CAUTION

This appliance is for household use only. Any servicing other than cleaning and user maintenance should be performed by an authorized service representative.

- Do not immerse base in water or try to disassemble.
- To reduce the risk of fire or electric shock, do not remove the base. No user serviceable parts inside. Repair should be done by authorized service personnel only.
- Check voltage to be sure that the voltage indicated on the name plate agrees with your voltage.
- Never use warm or hot water to fill the water container! Use cold water only!
- Keep your hands and the cord away from hot parts of the appliance during operation.
- Never clean with scouring powders or hard implements.

## JURA-CAPRESSO

Jura was founded in 1931 in Switzerland. Capresso was founded in 1994 in the USA. Both companies have joined forces in the US to bring you the finest Fully Automatic Coffee Centers available anywhere. With innovative and user-friendly features, high quality materials, clear instructions and superb customer service, we are sure you will experience the best coffee, espresso, cappuccino or latte you have ever had. We hope you will enjoy your new Fully Automatic Coffee Center and will recommend it to your friends. For more information about our products visit our website [www.capresso.com](http://www.capresso.com).

*Michael Kramm, President*

## Customer Service

**1-800-220-5701**

Mon-Thu 9AM – 9PM • Fri 9AM – 8PM • Sat 9AM – 5PM

Eastern Standard Time.

email: [contact@capresso.com](mailto:contact@capresso.com)

### **Jura-Capresso LLC.**

81 Ruckman Road, Closter, NJ 07624

201-767-3999 • Fax: 201-767-9684

Website: [www.capresso.com](http://www.capresso.com)

**Fig. 1**

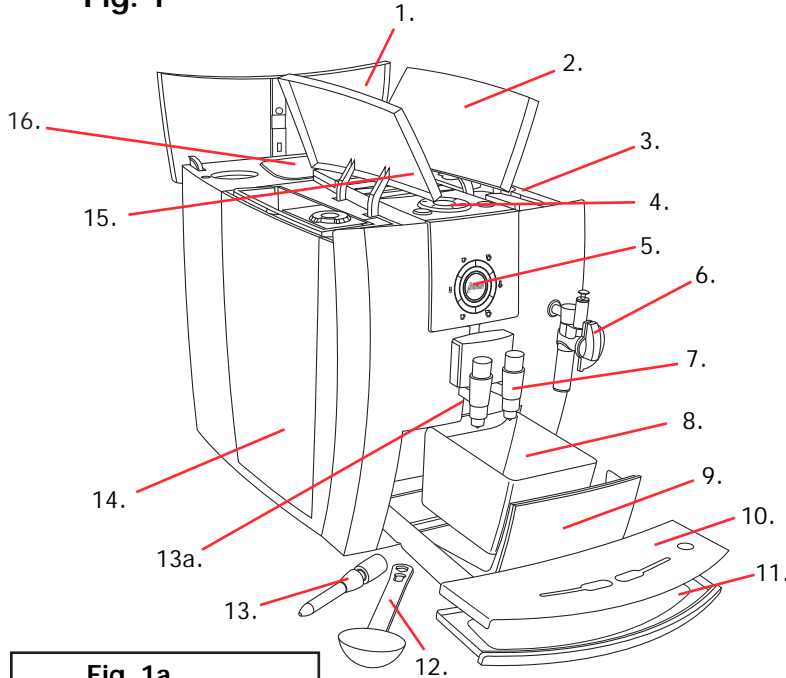

**Fig. 1a**

Main Power Switch and power cord located on right side of machine.

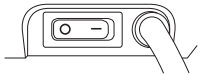

1. Bean container lid
2. Storage lid
3. Storage compartment
4. Control panel (see Fig. 2)
5. Beverage buttons (see Fig. 3)
6. frothXpress
7. Dual coffee spouts
8. Used coffee container
9. Removable tray
10. Stainless steel grid
11. Removable drawer
12. Measuring scoop (inside storage compartment)
13. Dual Frother Plus (inside storage compartment)
- 13a. Cup illumination
14. Removable water tank
15. Water tank lid
16. Bean aroma lid (see Fig. 4)

**Fig. 1b**

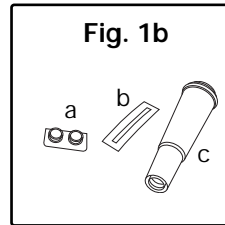

**Inside Welcome Pack:**

- a. Cleaning tablets
- b. Water hardness indicator strip
- c. Clearyl Water cartridge\* (unpacked without extension rod)

\* Attention: The Water Filter Cartridge should be in a pouch. If your machine comes with the cartridge installed, it is not a new machine! Call customer service 1-800-220-5701.

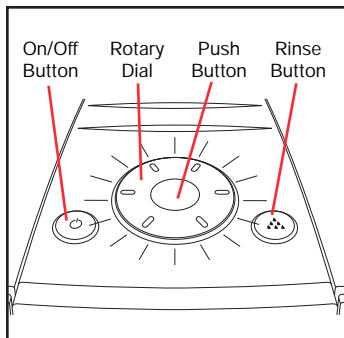

Fig. 2

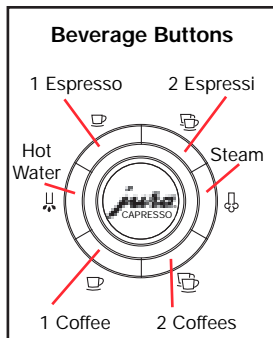

Fig. 3

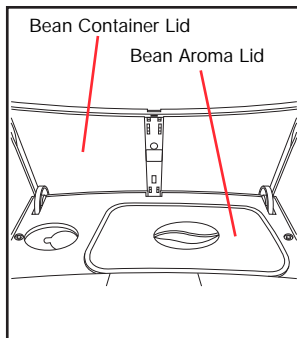

Fig. 4

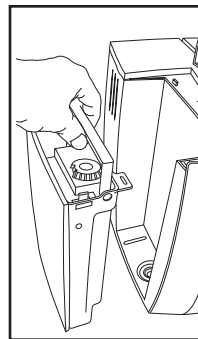

Fig. 5

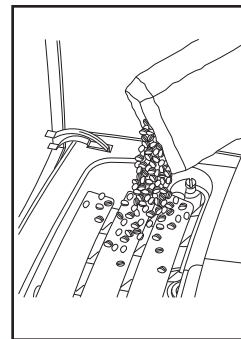

Fig. 6

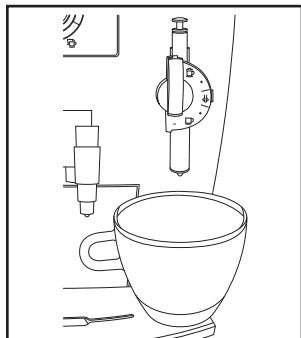

Fig. 7

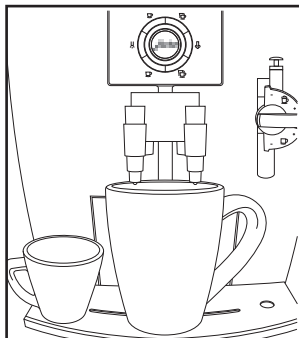

Fig. 8

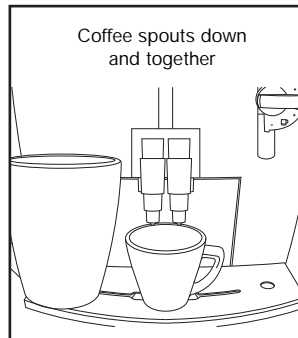

Fig. 9

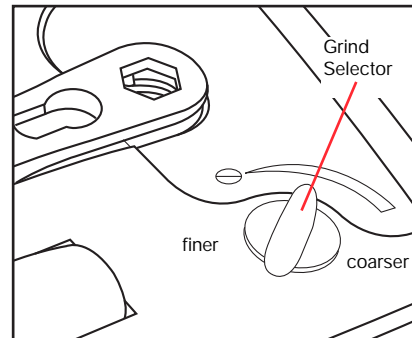

Fig. 10

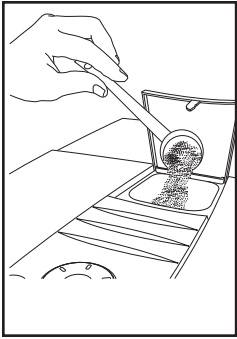

Fig. 11

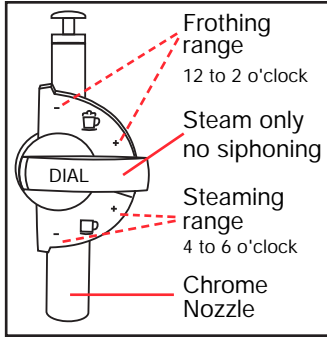

Fig. 12

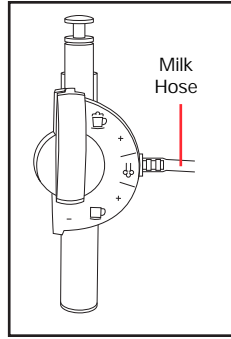

Fig. 13

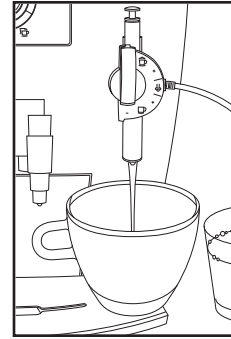

Fig. 14

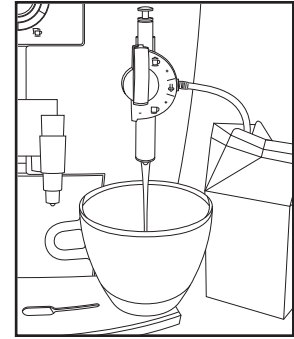

Fig. 15

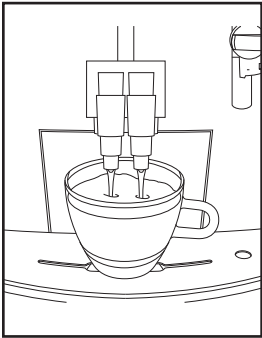

Fig. 16

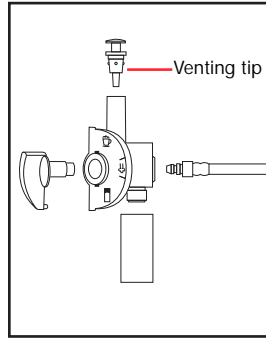

Fig. 17

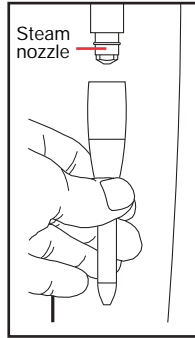

Fig. 18

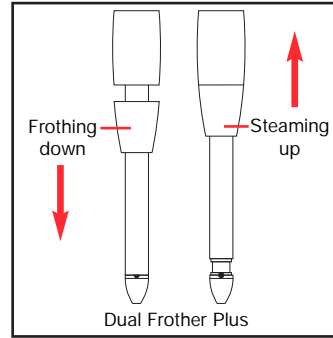

Fig. 19

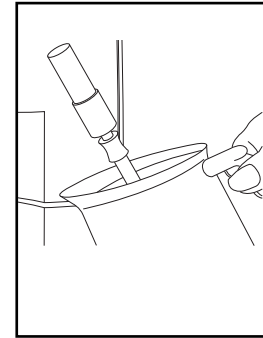

Fig. 20

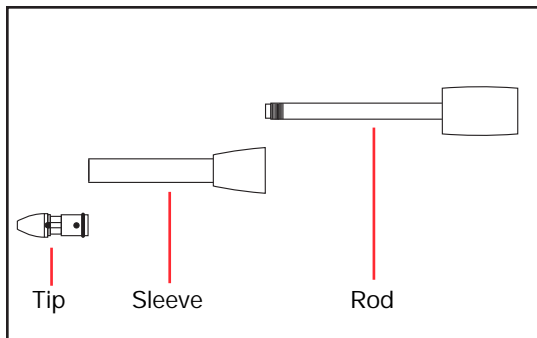

Fig. 21

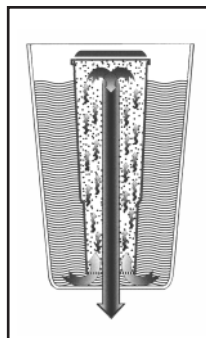

Fig. 22

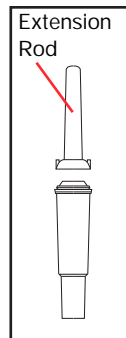

Fig. 23

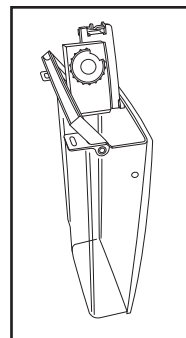

Fig. 24

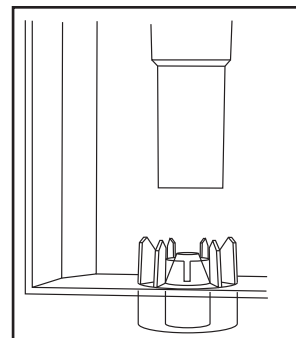

Fig. 25

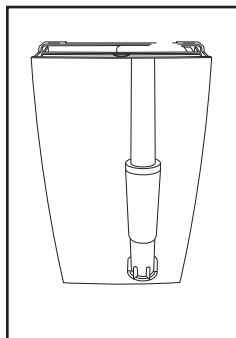

Fig. 26

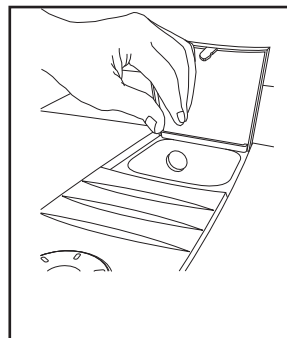

Fig. 27

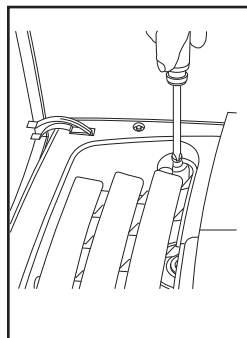

Fig. 28

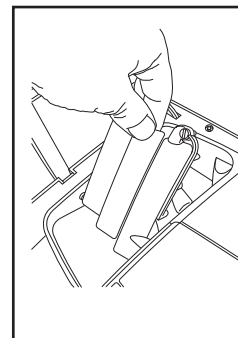

Fig. 29

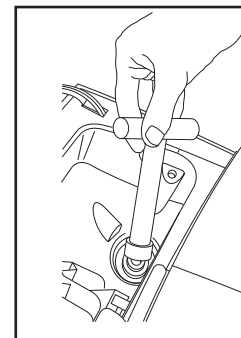

Fig. 30

# Table of Contents

Chapter	Page	Chapter	Page
Important Safeguards.....	2	9. Beverage Buttons .....	14
Customer Service Information .....	3	10. Tips for <b>HOTTER COFFEE</b> .....	14
Illustrations.....	4-7	11. <b>Brewing Coffee and Espresso</b> .....	15
1. Product Warranty Registrations.....	10	11.1 Overriding strength & cup size during brewing ....	15
2. Quick Reference Guide/Operating Inst./DVD.....	10	11.2 Visual programming of cup size .....	16
3. Welcome to the Impressa J5 .....	10	11.3 Using pre-ground coffee.....	16
3.1 Bean-to-Cup / “Crema”/High Pressure Brewing ....	11	12. <b>Cappuccino and Latte</b> .....	17
3.2. Different Coffee Drinks.....	11	12.1 Using the frothXpress system.....	17
3.3 Coffee Facts.....	11	12.1.1 Making Cappuccino and Latte .....	17
4. <b>Please Don’t / Please Do</b> .....	11	12.1.2 <b>HOTTER MILK</b> .....	18
5. Factory Settings.....	12	12.1.3 Making Hot Chocolate and Café Mocha .....	18
6. <b>Preparing the J5 for the first time</b> .....	12	12.1.4 Cleaning the frothXpress .....	19
6.1 Turning the machine on .....	13	12.1.5 Quick rinse .....	19
6.2 Filling the water tank.....	13	12.1.6 Thorough cleaning / Cappuccino Cleaner.....	19
6.3 About coffee beans.....	13	12.2 Using the Dual Frother Plus system .....	19
6.4 Filling the bean container.....	13	12.2.1 Cleaning the Dual Frother Plus.....	20
7. Adjusting the grinder.....	14	12.2.2 Cleaning the steam nozzle.....	20
8. <b>Daily Preparation</b> .....	14	13. Using hot water.....	20



# Table of Contents

Chapter	Page	Chapter	Page		
14.	Water Care .....	20	18.1 <b>Cleaning with special tablet</b> .....	28	
15.	<b>CLEARYL water filter cartridge</b> .....	21	18.2 Manual tablet cleaning cycle .....	28	
15.1	Installing and activating the CLEARLYL filter .....	21	18.3 Decalcifying.....	29	
15.2	Automatic CLEARLYL replacement .....	22	18.4 Manual decalcifying .....	30	
15.3	Manual CLEARLYL replacement.....	22	19.	Emptying system before transport .....	30
15.4	<b>Do not let the CLEARLYL filter dry out</b> .....	22	20.	Keeping your machine in top shape.....	30
16.	Water hardness monitor.....	22	20.1	Automated cleaning programs .....	31
16.1	Changing the water hardness monitor .....	23	20.2	Cleaning the bean container .....	31
17.	<b>Programming / Information / Maintenance</b> .....	23	20.3.	Cleaning metal contacts .....	31
17.1	Optional Cleaning Cycles .....	24	20.4	Cleaning the inside of the machine .....	31
17.2	Re-programming all beverage buttons.....	24	20.5	Cleaning the frothXpress and Dual Frother .....	31
17.3	Energy saving mode .....	25	21.	<b>Display messages</b> .....	31
17.4	Setting the time.....	26	22.	Troubleshooting.....	32
17.5	Setting the auto-on time .....	26	23.	Error messages .....	33
17.6	Changing the auto-off setting .....	26	24.	Removing stones from the burr grinder.....	34
17.7	Looking up information .....	27	25.	<b>Supplies</b> .....	34
17.8	Changing the display settings .....	27	26.	Warranty.....	35
17.9	Changing the language.....	28	27.	Free Repair Service.....	36
18.	Automatic cleaning cycles .....	28		Jura-Capresso address information.....	36

## 1. PRODUCT WARRANTY REGISTRATION

Please remove the Product Registration from the WELCOME PACK, fill it out and mail or fax it to us within two weeks after purchasing your machine or register your product online through our website: [www.capresso.com](http://www.capresso.com). **Important:** This registration is part of your warranty (chapter 26). In case your retailer sent the product registration when you purchased the machine, it is not necessary to register again.

## 2. QUICK REFERENCE GUIDE / OPERATING INSTRUCTIONS / DVD

Thank you for choosing this Jura-Capresso product.

**Important:** Do not try to start the machine without following the set-up steps in the Quick Reference Guide or the Operating Instructions.

- If you can't wait to get to your first cup of coffee or cappuccino, use the Quick Reference Guide. Enjoy! Keep it next to your machine, until you feel comfortable.
- Take the time to study the Operating Instructions. It covers all the great features of this machine. You will also find helpful hints and information that will enhance your enjoyment with coffee beverages.
- We highly recommend viewing the enclosed DVD.

## 3. WELCOME TO THE IMPRESSA J5

This fully automatic coffee center is completely programmable and extremely user friendly. Your Impressa J-series can prepare one or two cups of crema coffee at a time. The two-step pressure brewing system – well known in commercial applications – was adapted and refined by Jura coffee specialists and is the

trademark of each Jura-Capresso coffee center. This Pre-Brew Aroma-System ensures optimal coffee extraction, and the powerful 18-bar pump will finish every cup with a rich layer of "crema" – proof of perfectly high-pressure brewed coffee. Just press one of the four coffee beverage buttons and your Impressa J5 will grind, tamp and brew your personal cup of coffee. The integrated solid steel conical burr grinder grinds beans to the correct fineness. A separate funnel lets you use pre-ground coffee. The stainless steel lined ThermoBlock heating system prevents water from coming in contact with aluminum and allows you to brew coffee immediately after frothing (no purging). All coffee, water and steam functions are programmable to your own personal taste. Brew coffee between 1 and 16 oz. The unique dual coffee spout moves up and down and in and out to accommodate a wide variety of cups. The frothXpress system is an automatic frothing system that takes the guess work out of steaming and frothing milk. If you prefer the traditional steaming and frothing, use the Dual Frother (stored in the storage compartment). The steam nozzle produces unlimited amount of steam. The hot water function lets you prepare tea and other beverages in seconds or use it to pre-warm your coffee cups. All important functions such as water level, bean container, used coffee container and water filter are monitored automatically. You can program the machine to turn itself on and off, change the language and check how many cups of coffee you made.

Smooth, clean lines, elegant accents and an all-encompassing attention to detail make the J5 an aesthetic masterpiece from any angle. High-end materials, a rich platinum metallic front treatment and tasteful chrome accents on top, compliment the

black or white finish. The cup/coffee illumination lets you enjoy the coffee preparation (Fig.1.13a). Enjoy your Impressa J5!

### 3.1 BEAN-TO-CUP / "CREMA COFFEE" / HIGH PRESSURE BREWING

According to the majority of coffee experts, grinding the beans just before brewing, tamping and brewing under high pressure is the ideal extracting process for maximum flavor and aroma. Your Jura-Capresso automatic coffee center will always produce espresso and coffee with a thick, foamy layer called "crema." The crema traps the fine aromatics and the light gaseous flavors that register on the palate. The high pressure and the short brewing time prevent the extraction of bitter oils and release less caffeine than any other brewing method. You will always make the absolute freshest and most aromatic cup of coffee. This is the reason why many European restaurants and hotels serve only fresh pressured brewed coffee. Experiment with your new machine and prepare yourself the best and most enjoyable cup of coffee!

### 3.2 DIFFERENT COFFEE DRINKS

Here are some guidelines for the most popular coffee drinks:

- Ristretto: 1/2 to 1 oz. of coffee. Sweeten to taste
- Espresso: 1 to 2 oz. coffee. Sweeten to taste
- Double Shot: 3 to 4 oz. of coffee. Sweeten to taste
- Crema Coffee: 5 to 8 oz. of coffee
- Cappuccino: Espresso plus 3 to 4 oz. of hot frothed milk
- Latte: Espresso plus 3-5 oz. steamed milk with little or no froth
- Café Mocha: Add chocolate syrup to milk then steam and froth and add espresso.

Experiment with the size of your milk based drinks. For stronger coffee taste add more coffee, for more milk taste add more frothed milk.

### 3.3 COFFEE FACTS

- **Caffeine** is tasteless. A "strong" coffee or espresso is mostly the result of the amount of coffee in relation to the amount of water. The longer a bean is roasted, the less caffeine it has.
- **Arabica and Robusta** are two genetically different kinds of beans. "Arabica" beans have more flavor and a little less caffeine than "Robusta" beans which are mostly used in lower priced coffees and instant coffees.
- **Espresso** is not a bean, it's the way the coffee is roasted and prepared. Typical US espresso roasts result in darker beans with an oily surface. European espresso roasts are medium brown with no or very little oils on the surface.

**Please note:** Dark, oily beans should be processed differently than medium brown beans: see chapter 7.

---

All Display Messages Are Shown in **RED**

---

### 4. PLEASE, DON'T... (or you void your warranty protection):

- Never pull out the drawer during the brewing process. Only pull the drawer when the display instructs you or when the display shows **READY**.
- Never fill instant coffee into the bean container or ground coffee funnel; it can damage the brewing chamber.
- Never fill sugar coated coffee beans into the bean container.
- Never fill frozen beans into the bean container. If you store beans in the freezer, let them thaw 3 to 4 hours before filling them into the bean container.

- Never fill anything other than coffee beans into the bean container (no chocolate, rice, nuts, spices, etc.)
- Never fill anything but fresh, cold clean water into the water container, except when decalcifying (chapter 18.3).
- Never use mineral or carbonated water. You can use tap water, bottled water, spring water, distilled water and reverse osmosis water.
- Never repair or open the machine yourself. All repairs should be performed only by an authorized service center.
- Do not place the machine on a surface which is sensitive to hot or cold water and steam.

**PLEASE, DO...**

- Fill water tank with fresh, cold water only.
- Remove any foreign particles (small stones) from coffee beans.
- Let frozen beans thaw 3 to 4 hours before pouring them into the bean container.

**5. FACTORY SETTINGS**

Each machine leaves the factory with the following pre-sets:

- Steam Button.....20 seconds
- Hot Water Button...6 oz., temp. HOT
- 1 Espresso Button....1.5 oz., temp. HIGH, coffee strength: STRONG
- 2 Espresso Button .....1.5 oz. (per cup!), temp. HIGH
- 1 Coffee Button .....5.0 oz., temp. HIGH, coffee strength: NORMAL
- 2 Coffee Button .....5.0 oz.(per cup), temp. HIGH

**Please note:** You can change all above pre-sets (chapter 17.2). You can also override the strengths and the cup size before/ during actual brewing. Overriding will not change the preset values (chapter 11.1).

Other functions are set as follows (to change functions refer to listed chapters.)

	<b>chapter</b>
Filter (Clearyl).....- not installed .....	15.1
Hardness Level..... 10° dH .....	16
Auto-Off..... 2 Hours.....	17.6
Grinder Fineness ..... Middle position ....	7
Energy Saving .....	- not set..... 17.3
Time format .....	AM/PM ..... 17.8
Volume format .....	in ounces OZ ..... 17.8
Language .....	English ..... 17.9
Time .....	not set ..... 17.4
Unit On (Auto-On) .....	not set ..... 17.5

**CUP ILLUMINATION** (Fig. 1.13a)

The cup illumination adds a dramatic touch to brewing coffee. Providing the main power switch is on, you can activate the cup illumination for 1 minute by pressing any button.

**6. PREPARING THE J5 FOR THE FIRST TIME**

Make sure

- all accessories, literature, caution leaflets etc. are removed from the machine, the water tank, and the bean container.
  - the Clearyl Water Filter is NOT installed!
  - the machine sits on a flat, even surface and the drawer, tray and used coffee container are inserted (Fig 2).
  - machine is NOT placed on a surface which is sensitive to heat, water and steam.
- Plug-in machine.

## 6.1 TURNING THE MACHINE ON

- Press the Main Power Switch at the bottom right in front of the power cord (Fig. 1a). The On/Off button on top of the machine illuminates in red (Fig. 2), indicating that the main power switch was turned on.
- Push the On/Off button on top of the machine. The display will illuminate. **FILL WATER TANK**

## 6.2 FILLING THE WATER TANK

**Please note:** Only use fresh, cold water. Never fill water tank with carbonated water, milk or any other liquid.

- Open the Water Tank Lid, remove the water tank, rinse and fill with fresh, cold water (Fig. 5).
- Replace water tank and make sure that the two slots are engaged over the two hooks to secure the tank properly.
- Close water tank lid. The display shows **PRESS RINSE** and the Rinse Button illuminates (Fig. 2)
- Place one cup underneath the Steam Outlet (Fig. 7)
- Push the Rinse Button. **SYSTEM FILLING**. The machine starts pumping water into the system, until some water will come through the cappuccino nozzle. After a few seconds the process stops and the display shows **HEATING**.
- Place a cup underneath the dual coffee spouts (Fig. 8). After approx. one minute the display shows **PRESS RINSE**.
- Push the Rinse button. Warm water pumps through the coffee spouts and stops. The display shows **FILL BEANS**.

## 6.3 ABOUT COFFEE BEANS

**Frozen Beans:** Thaw 3 to 4 hours before adding to bean container. This prevents moisture from seeping into the grinder.

**Oily Beans:** Beans with an oily surface tend to stick together. This may prevent a continuous flow of beans from the bean container into the burrs. As a result the grinder does not grind enough coffee and you might get weak or no coffee at all. Before filling oily beans into the bean container pour the beans in an open bowl and let them sit for about 5 hours. The oils will evaporate (this will not change the taste of your coffee). Then fill the beans into the bean container. Now beans will feed into the burr grinder more easily.

**Flavored Coffee:** DO NOT use flavored beans in the grinder! If you like flavored coffees we recommend to add flavors to your coffee after brewing. This way you can use your regular coffee beans in the bean container. Adding the flavors after brewing lets you control the intensity better than with pre-flavored coffee. Your local coffee store typically carries a variety of flavors.

## 6.4 FILLING THE BEAN CONTAINER

**Please note:** To insure that your conical burr grinder will work for a long time, do not use it with any kind of coated or flavored beans (all coating and flavors contain sugar or sugar substances). Such coating can damage the burrs. Using such beans voids the warranty. Have your coffee store grind the sugar coated beans and use as described in the chapter 11.3.

- Open the Bean Container Lid (Fig. 4). Do not force the lid further back than the vertical position.
- Remove the bean aroma lid (Fig. 4). The bean container has a protective slotted cover. This prevents fingers from getting into the burrs during grinding. This slotted cover can be opened by loosening the holding screw (Fig. 28) (chapter 20.2). The bean container has a sensor which monitors the bean level. It will

remind you via the display when to refill the beans before the bean container is completely empty.

- Fill beans into the bean container.
- Place a cup underneath the Dual Coffee Spout and push the 1-cup Espresso Button (Fig. 3). The machine starts grinding and brewing. The display may still show **FILL BEANS**.
- Push the 1-cup Espresso Button again. Discard the first two cups of coffee. **READY**. Your next cup of coffee will be perfect.

## 7. ADJUSTING THE GRINDER (Fig. 10)

- Open the storage lid (Fig. 1.2). The grinder adjustment is set to a medium fineness position. We recommend to leave the grinder in this position for most applications. If you have extremely dark roasted, oily beans we recommend to set the grinder to a coarser setting (towards the thick end of the bar).

**Important:** You can only adjust the grind settings, while the grinder is running.

- While the grinder is running turn the grind selector switch to the desired position.
  - For dark, oily beans turn the selector switch toward the thicker end of the bar (away from the bean symbol).
  - For light, dry beans turn selector switch toward bean symbol.

## 8. DAILY PREPARATION

We recommend filling the water container every morning with fresh, cold water. This will enhance the taste of your coffee.

- Make sure the Main Power Switch is on (Fig. 1a). In this case the On/Off button on top is illuminated.
- Push the On/Off button on top of the machine. **HEATING**. After approx. 1 to 2 minutes the display shows **RINSE**.
- Place a cup under the coffee spouts (Fig. 8) and push the

Rinse Button (Fig. 2). Hot water pumps through the coffee spouts. The rinse cycle stops by itself and the display reads: **READY**. You are now ready to make coffee.

## 9. BEVERAGE BUTTONS (Fig. 3)

The J5 has six beverage buttons: four coffee buttons, a hot water button and a steam button. These buttons are all pre-programmed (see chapter 5). If you want to re-program them, see chapter 17.2.

## 10. TIPS FOR HOTTER COFFEE

- Always make sure the temperature setting for your coffee beverage is set to HIGH (chapters 5 and 17.2). Some coffee drinkers like their coffee extremely hot. High pressure brewed coffee will lose its flavor and aroma if it is brewed too hot. In addition the “crema” on top of your coffee will disappear within seconds if the coffee is brewed too hot.

Contrary to drip coffee (which is normally brewed into a carafe sitting on a hot plate) the J5 brews coffee directly into your cup. Since the cup is at room temperature or even colder it will immediately take away warmth from your coffee beverage.

### Black Coffee / Espresso:

- We highly recommend to pre-warm your cup. The fastest way is to place the cup under the frother and push the Hot Water Button (Fig. 3). Fill the cup with 2 to 6 oz. of hot water. Then empty the cup. Now prepare your coffee.
- In addition you can increase the temperature of the coffee by turning the grind fineness selector to a slightly finer setting (see chapter 7). The finer grind will slow down the brewing process thus increasing the water temperature. This might result in less crema on top of your coffee / espresso.

### Extremely Hot Coffee:

If you like your coffee even hotter you can inject steam. This will make the crema disappear.

- Slip on the Dual Frother Plus (Fig. 18)
- Push the Steam button (Fig. 3). The display shows **HEATING**. After a few seconds the display shows **READY**.
- Immerse the tip of the Dual Frother into your cup of coffee and push the Steam button again. Hot steam is injected.
- Push any button to stop the steam injection.

**CAUTION:** If you steam the coffee too long it will begin to boil and possibly splash from your cup.

### Coffee with Milk:

If you normally add cold milk to your coffee we recommend to pre-warm your milk. Proceed as follows:

- First add cold milk to your pre-warmed cup.
- Use the Dual Frother to steam the milk (Fig. 18, 19, 20)
- Push the Steam button: **HEATING**. It will take a few seconds for the system to be ready for steam.
- When the display shows **READY**, immerse the tip of the Dual Frother into the milk and push the Steam Button. **STEAM**. Let the hot steam warm up the milk for a few seconds.
- Then push the steam button again, to stop.
- Now place the cup under the coffee spouts and add your coffee.

## 11. BREWING COFFEE AND ESPRESSO

(1 ESPRESSO, 2 ESPRESSI, 1 COFFEE, 2 COFFEES)

- Place one or two cups underneath Dual Coffee Spouts and push the desired button.

The Impressa J5 will grind, tamp and then brew the coffee. It

uses a 2-step brewing process (Pre-Brew Aroma System).

First, it moistens the ground coffee (pre-brew phase), pauses for a few seconds, and then starts the brewing process. The display will show the name of the button you pushed, e.g.

**1 ESPRESSO** and then the strength, e.g. **STRONG** and then **1 ESPRESSO** again. The brewing process stops automatically as soon as the programmed volume of coffee is produced.

**Very Important:** After the brewing stops, the J5 will discard the used coffee. **Please do not pull out the drawer (Fig. 1.11) during this time. It can seriously damage the machine.** There is no need to pull out the drawer unless you see the message **EMPTY GROUNDS**, see chapter 21.

When the display shows **READY** you can brew the next cup of coffee.

**Please note:** You can always stop the brewing process by pushing the Rotary Dial or any of the beverage buttons.

This will not affect the programmed values.

### 11.1 OVERRIDING STRENGTH AND CUP SIZE DURING BREWING.

With the J5's override feature you are always able to change certain settings just before brewing without affecting the pre-set values. This is a great feature if you desire a different kind of coffee which is not programmed. (For changing programmed values see chapter 17.2).

- For the two single-cup coffee buttons you can override the strength and the coffee volume.
- For the two double-cup coffee buttons you can override the coffee volume (those two buttons will always brew in the XSTRONG setting).

- For the hot water button you can override the water volume.
- For the steam button you can override the steam duration.

**Important:**

- You always override the coffee strength, before you push one of the single-cup buttons.
- Coffee and Hot Water volume as well as steam duration you override after you push any of the beverage buttons.

**Example:**

Your 1-cup espresso button is programmed to **STRONG** 1.5 oz. Somebody wants a **MILD** 2oz. espresso.

**READY**

- Place a cup underneath the dual coffee spouts.
- Turn the Rotary Dial. The display shows four different strength settings **MILD, NORMAL, STRONG, XSTRONG**.
- Select **MILD** then push the 1-Espresso button. **1 ESPRESSO, MILD**.
- While the J5 is grinding, turn the dial again. This time it will show the coffee volume. Select **2.0 OZ**. The J5 will produce a 2.0 oz mild espresso and will stop automatically. **READY**.

The next time you push the 1 cup espresso button it will produce the programmed setting (STRONG 1.5 oz.)

**Please note:** When you select a different strength you must push one of the coffee buttons within the next 3 seconds, otherwise the J5 reverts back to **READY**.

**Please note:** When you push one of the double cup buttons and you change the volume, the display will always show the volume per cup, e.g. if you choose 7 oz. the Z5 will actually brew a total of 14 oz.

## 11.2 VISUAL PROGRAMMING OF CUP SIZE

Instead of overriding the volume or duration of the beverage buttons you can re-program the cup size and the duration of the steam by going into the programming functions (chapter 17.2) or by visually programming the output.

**Example:** you want to make sure your personal espresso cup is filled to the rim.

**READY.**

- Place the cup under the coffee spouts.
- Push and hold the 1-cup Espresso button until the display shows **ENOUGH COFFEE ?**. The J5 starts grinding and brewing espresso.
- Push the 1-cup Espresso button just before your cup is full and the display shows **OK**, then **1 ESPRESSO**. This is now the new programmed volume for the 1-cup Espresso button.

This Push and Hold feature works for all four coffee buttons and the steam and hot water button.

## 11.3 USING PRE-GROUND COFFEE (Fig. 11)

You can also use pre-ground coffee, bypassing the grinder. This comes in handy if someone requests decaf coffee or a decaf cappuccino. You can also use the pre-ground funnel for ground flavored coffee.

**IMPORTANT:**

- Never fill the funnel with instant coffee.
- Do not fill the funnel with more than two scoops. The funnel is not a coffee storage container.
- If coffee is ground too fine it might be processed very slowly or the J5 will interrupt the process altogether.



- **READY** Place one or two cups under the Dual Coffee Spouts.
- Open the Lid for Ground Coffee (Fig. 11). Opening this lid automatically disengages the grinder. The display shows repeatedly **FILL PRE-GROUND**.
- Add one or two level scoops of pre-ground coffee into the funnel and close the lid. The display shows **SELECT BUTTON**.
- Push any of the four coffee buttons. The J5 brews the selected beverage without grinding. During brewing you can still change the coffee volume by turning the Rotary Dial. **READY**

**Please note:** If you inadvertently opened the lid for the coffee funnel, just close it. The J5 will detect that there is no coffee in the funnel. The display will show **NOT ENOUGH PRE-GROUND** and will return to **READY**.

**Please note:** After using pre-ground sugar coated or flavored coffee through the coffee funnel you may experience some flavor transfer when switching back to your regular coffee. Select the program **RINSE** in the maintenance section to run hot water through the coffee spouts (chapter 17.1).

## 12. CAPPUCCINO AND LATTE

**Frothing milk for Cappuccino:** Injecting hot steam into the milk to warm the milk and create a frothy layer of tiny bubbles.

**Steaming milk for Latte:** Injecting hot steam to warm the milk without creating a frothy layer.

The J5 is equipped with two different frothing/steaming systems:

- a) The frothXpress system - mounted on the machine.
- b) The Dual Frother PLUS - located in the storage area (Fig. 1.3)

### **Recommendation:**

- If you froth for only one or two cups and want 100% control over the frothing/steaming process, the Dual Frother PLUS

might be the preferred equipment.

- If you always want the same amount of milk and milk froth in your cup or you make multiple cappuccinos the frothXpress is faster and more convenient to use.
- Make yourself familiar with both systems.

## 12.1 USING THE FROTHXPRESS SYSTEM

The frothXpress system lets you produce hot steamed or frothed milk right into your cup(s). After becoming familiar with this attachment you will be able to get exactly the amount of frothed or steamed milk you want in your cup (refer to the video).

- Remove the red protective cap from the side of the frothXpress system and attach the milk hose (from the welcome pack) with the black connector into the opening of the frothXpress (Fig. 13).
- Insert the other end into your milk carton or any container with cold milk (Fig. 14).

**Important:** This system siphons milk and mixes it inside the frothXpress with hot steam. It is necessary that all parts are connected tightly, otherwise the siphoning process will not work.

**Frothing Position:** Point the dial between 12 and 2 o'clock.

Turning the dial towards the 2 o'clock position will reduce the amount of froth but will increase the temperature of the milk. Milk will be siphoned, heated and frothed. Fig. 13 shows the 12 o'clock position.

**Steaming Position:** Point the dial between the 4 and 6 o'clock position. Milk will be siphoned and heated with no froth. For hotter milk move the dial more towards the 4 o'clock position.

**Steam Only Position:** When the dial points to the 3 o'clock position, the siphoning of the milk is blocked. Only steam will pass through the frothXpress. Fig. 12 shows that exact position.

### 12.1.1 MAKING CAPPUCCINO AND LATTE

- Pre-warm your cappuccino cup.
- Place your cup underneath the frothXpress (Fig. 15).
- Push the steam button (Fig. 3 ) **HEATING**. It will take a few seconds for the system to be ready for steam.
- Make sure the dial of the frothXpress is in the range between 12 and 2 o'clock.
- When the display shows **READY** push the steam button again. **STEAM**. The frothXpress starts siphoning the milk and delivers hot frothed milk into your cup. The factory setting for steam is 20 seconds. After 20 seconds the frothing will stop. **READY**.
- If you want two cappuccinos, move the first cup aside and place the next cup underneath the frothXpress and push the steam button again. The above process repeats itself.
- You can also prepare for a **Latte** now. Turn the frothXpress dial to a position between 4 and 6 o'clock, place the cup underneath the frothXpress and push the steam button. Steamed milk without froth will be produced.
- Now place your cup(s) under the coffee spouts and push the 1-cup or 2-cup espresso button. The coffee will flow into your cups. Now you have two cappuccinos or one cappuccino and one latte.
- Stir lightly so that the coffee and the milk form a nice brown color below the milk froth (see video). Enjoy!

#### *Please note:*

- After the steam output stops, the J5 will hold the **STEAM READY** function for approx. 40 seconds. This allows you to add more steamed/frothed milk to the cups, or increase the milk temperature (see below) or froth more milk.
- Once you push any of the coffee buttons, the **STEAM READY**

function is cancelled. The next time you push the steam button, the system will first display **HEATING** and then **READY**.

#### **How much froth?**

Skim milk will produce more froth than regular milk. The frothXpress system will always create more froth than the Dual Frother system.

### 12.1.2 HOTTER MILK

In order to get proper froth the milk cannot be too hot, otherwise no froth will be created with the siphoning system. For most users the milk temperature created with the dial at the 2 o'clock position will be hot enough. You can increase the milk temperature as follows:

- After the frothing stops, turn the frothXpress dial to the 3 o'clock position, steam only (Fig. 12).
- Raise the cup containing the frothed milk so that the chrome nozzle is immersed.
- Push the steam button again. **STEAM**. Now steam will be injected into the milk.
- After a few seconds push the steam button again to stop this process. **Warning:** the milk is now extremely hot and might burn you.

### 12.1.3 MAKING HOT CHOCOLATE AND CAFE MOCHA

The frothXpress is ideal to produce unlimited amounts of hot chocolate. Add chocolate syrup to taste to the cold milk and stir well. Then follow the steps under chapter 12.1.1. If you add one or two shots of espresso you have created a CAFÉ MOCHA.

### 12.1.4 CLEANING THE FROTHXPRESS

After frothing, a few drops of milk are still inside the frothXpress.

### 12.1.5 QUICK RINSE

If you don't use the frothXpress within the next half hour there is a quick and easy way to remove those milk deposits.

- Place a cup underneath the frothXpress
- Place a cup with some cold water next to the machine and insert the other end of the milk hose into this cup (Fig. 14). The frothXpress dial points at the 12 o'clock position. **READY**.
- Push the Steam Button (Fig. 3). **HEATING**. When the display shows **READY** push the Steam button again **STEAM**. The system will push steam through the frothXpress.
- Push the Steam button to stop.

### 12.1.6 THOROUGH CLEANING / CAPPUCCINO CLEANER

If you use the frothXpress extensively or in case you forgot to clean the frothXpress, it is possible that milk fat starts building up inside the frothXpress.

The J5 comes with a bottle of milk fat dissolver (Cappuccino Cleaner). This is the fastest and easiest way to remove any milk residue from the frothXpress.

- Remove the frothXpress from the nozzle.
- Take the frothXpress apart (Fig. 17).
- Place all parts including the hose in a cup with warm water and add one cap-full (15 ml or 1/2oz.) of the cappuccino liquid.
- Let sit for ten minutes or overnight.
- Rinse all parts under fresh water and assemble.

### 12.2 USING THE DUAL FROTHER PLUS

The Dual Frother Plus is ideal if you want to froth or steam milk

for just one or two cups of latte or cappuccino.

Remove the frothXpress, take the Dual Frother out of the storage compartment and attach to the steam nozzle (Fig. 18)

**Frothing Position:** The cylinder of the frother is pushed down.

**Steaming Position:** The cylinder is pushed up ( see Fig. 19).

- Fill the desired amount of milk into a pitcher or in your cup. Make sure that the pitcher or the cup has at least twice the volume of the milk, e.g. if you steam or froth 5 oz. of milk use a 10 to 12 oz. pitcher.
  - Always start with cold milk. Skim milk will produce the most froth and will let you taste more of the coffee. Milk with 1% and 2% fat will give you a bit less froth. Regular milk (3% fat) will produce even less froth. The Dual Frother with its new tip design will create a dense froth.
  - The steam button is set to 20 seconds of steaming.
  - Push the steam button (Fig. 3). Display shows **HEATING**.
  - When the display shows **READY** immerse the tip of the frother into the milk (Fig. 20) and push the steam button. With the cylinder pushed down, small frothing bubbles will build up on the surface. With the cylinder pushed up, steam will heat up the milk without creating froth. Both positions will create a distinctive sound.
- IMPORTANT:**
- If the steam output stops, you can push the steam button again and continue.
  - You can always stop the frothing action by pushing any of the beverage buttons.
  - When you are finished with frothing/steaming set the pitcher aside and prepare a shot or a double shot of espresso. Add the frothed/steam milk to taste.

### ***Tips for frothing (Cappuccino):***

The tip of the frother should not touch the bottom of your pitcher. Start in the steaming position – cylinder "up" (Fig. 19) – for a few seconds. Then push the cylinder "down". Milk froth will build up. This way the froth on top of your milk is also warm. If the frothed milk is not warm enough, continue in the steaming position. Steaming and frothing directly in your cappuccino/latte cup: With practice, you can steam and froth directly in your cappuccino cup. First steam and froth the milk, then add your espresso shot.

#### **12.2.1 CLEANING THE DUAL FROTHER PLUS**

Always keep the Dual Frother Plus clean. The two side holes and the groove of the frother tip must be free of milk deposits (Fig. 21). If these parts contain hardened milk particles, it will be impossible to froth milk properly.

##### **Fast cleaning:**

**READY.** Place a cup underneath the frother and push the Hot Water button (Fig. 3). Let hot water run through the frother for about 3 seconds and then stop. This will flush out any small milk droplets.

##### **Thorough cleaning of the Dual Frother parts:**

- Remove the Dual Frother from the Steam Nozzle (Fig. 18) and take apart (Fig. 21)
- Soak all three parts in warm water and add a half a cap of the cappuccino cleaner liquid. Let sit for 10 minutes or overnight.
- Rinse with fresh water and assemble.

#### **12.2.2 CLEANING THE STEAM NOZZLE** (Fig. 18)

- Place a cup underneath the Steam Nozzle (the Dual Frother is

off) and let a bit of hot water run through the Steam Nozzle.

**Tip:** If the steam nozzle is blocked by hardened milk, use a needle, toothpick or paper clip and loosen up the milk deposit. Then let some hot water pass through the Steam Nozzle.

### **13. USING HOT WATER**

With the hot water button you can

- pre-warm your coffee cups,
- make tea,
- add hot water to an espresso to create a Café Americano,
- wet a paper towel to clean the surface and the drip tray.

The factory setting of the hot water button is 5 oz. and temperature setting **HOT**.

You can override the volume during operation as follows.

- Place a cup underneath the frother. **READY**.
- Push the hot water button. Display shows **WATER** and then briefly **HOT** then **WATER** again.
- While water is pumped through the frother turn the rotary dial to increase (up to 15 oz.) or decrease the volume.
- You can always stop the flow of hot water by pushing any beverage button or the button inside the rotary dial.

### **14. WATER CARE**

Water is heated inside the machine. This leads to calcium deposits forming inside the machine. The J5 works with:

- regular tap water • bottled water • distilled water.

We recommend using regular tap water or bottled water. Distilled water has no minerals and does not improve the taste of coffee.

Tap water has a varying degree of water hardness (chapter 16).

Most bottled water has a low level of water hardness.

**IMPORTANT:** do not use carbonated water or any other liquid in the water tank.

You have the following options to take care of the water.

- Clearyl Water Filter Cartridge (chapter 15).
- Decalcifying System (chapter 18.3).

Your machine is pre-set in the factory to automatically remind you to decalcify based on a water hardness of Level 2. You can change the water hardness setting to comply with the water you are using (chapter 16.1).

**Please note:** The machine will automatically remind you when it is necessary to run certain water maintenance programs. It is important that you follow those instructions. Otherwise your machine may not function properly.

## 15. CLEARYL WATER FILTER CARTRIDGE

The machine comes with one Clearyl Water Filter Cartridge.

To reorder cartridges, see chapter 25.

### The Clearyl cartridge

- transforms your tap water into pH-neutral water and reduces water hardness up to 75%,
- cleans the water through an upward current principle (Fig. 22) just before the brewing cycle starts, ensuring freshly filtered water every time you make coffee,
- removes (if present) up to 85% chlorine, up to 90% lead, up to 95% copper and up to 67% aluminum,
- contains only pure organic materials (ion exchangers and active carbon) with no chemical additives,
- preserves fluorides and minerals,
- eliminates decalcifying except when using extremely hard water (25 grains or higher), see chapter 16. In this case we recommended to decalcify the machine once or twice a year.

## 15.1 INSTALLING AND ACTIVATING THE CLEARYL FILTER

**Important:** Never install the cartridge before or during "Preparing Machine For The First Time" (chapter 6).

### READY

1. Push and hold the Rotary Dial until the display shows **RINSE**.
2. Turn the Dial clockwise until the display shows **FILTER –**.
3. Push the Rotary dial. The display shows **NO –**.
4. Turn the dial until **YES** appears and push the dial again. **OK**.
5. The display shows alternating **INSERT RINSE** and the rinse button illuminates.
6. Remove the Clearyl cartridge from its bag and rinse cartridge under water.
7. Add the extension rod to the cartridge (Fig. 23).
8. Remove the water tank, make sure it is empty.
9. Pull up the cartridge holder and insert the cartridge with its tapered end down into the water container (Fig. 24, 25, 26).
10. Make sure it fits securely inside the fins. Push down gently (Fig. 25).
11. Close the cartridge holder. Make sure the holder snaps into place.
12. Fill the water tank with fresh cold water and replace.
13. Place a 20 oz. container under the steam nozzle (Fig. 18).
14. Press the rinse button. **FILTER RINSING**.
15. Approx. 16 oz of cold water is pushed through the filter and through the frother. The rinsing water might be slightly discolored. This is not harmful and does not affect the taste of your next coffee. The rinsing stops automatically.

### HEATING. READY.

**Please note:** As long as the filter is activated, the water hardness setting is automatically turned off.

## 15.2 AUTOMATIC CLEARYL REPLACEMENT

Eventually the filter needs to be replaced. Over time and depending on the amount of water, the filter will cease to work. The machine cannot monitor the time aspect. It monitors the water volume. After approx. 75 liters of water use (~2,500 oz.) the display shows alternating **READY FILTER** and the rinse button illuminates. It's time to replace the filter.

**Important:** If the filter is older than two months it needs to be replaced, regardless how much water has been processed. At that time the filter has lost its calcium suppressing abilities and calcium will build up inside the machine. Since the Water Hardness Selector is off, the machine will not remind you when to decalcify. This could clog and damage your machine.

### READY FILTER

1. Push the Rinse Button. **CHANGE**
2. Remove the water tank.
3. Remove the old filter and unclip the extension rod aside.

**IMPORTANT:** Keep the extension rod (Fig. 23). The used filter cartridge is environmentally friendly and can be disposed with your regular household trash.

4. Remove the new cartridge from its bag and rinse under running water.
5. Now install as explained in chapter 15.1, steps 7 to 15.

## 15.3 MANUAL CLEARYL REPLACEMENT

If the filter is more than 2 months old and you have not used 75 liters of water replace the filter as follows:

- **READY.** Push the rotary dial until the display shows **RINSE.**
- Push the Rotary dial again. **RINSE.**
- Turn the dial until the display shows **FILTER.**

- Push the dial. The display shows **CHANGE.**
- Continue as described in chapter 15.2, steps 2 to 5.

## 15.4 DO NOT LET THE CLEARYL FILTER DRY OUT!

If the filter is not immersed in water for a few days the granular inside will dry out and will block any water from passing through.

- If you don't use the machine for a few days, always leave some water in the water tank. This way the filter will not dry out. Once you start using the machine again, fill the water tank with fresh water and process approx. 2 oz. of water through the hot water spout. Now you have totally fresh water for your first cup of coffee.
- If you don't use the machine for a longer period of time, empty the water container and remove the CLEARYL filter. Fill a glass with at least 2 inches of water and immerse the filter. Place the glass in the refrigerator. Don't lose the extension rod (Fig. 23).
- When you start using the machine again, install the filter.

## 16. WATER HARDNESS MONITOR

Your J5 is set to a water hardness of 10°dH. If you have not activated the Clearyl Cartridge the J5 will remind you when it is time to perform a decalcifying cycle. The machine is set to medium hard water. If you have harder water you need to set it to a higher level. If you have softer water you can set it to a lower level. If you are not sure about the hardness of your water, ask your local water company for the "Water Hardness in Grains." The machine will show you the water hardness in the German hardness scale (which is a bit different from the American "Grain" scale (see chart below). You can also use the enclosed water hardness indicator strip to determine the water hardness:

- Insert the stick for one second into the water you want to use. Shake off any access water and wait for one minute.
- If all five fields of the test stick turn reddish, set the hardness level to 5 squares. If four fields turn reddish, set the hardness level to 4 squares and so on.

**Please note:** If you use Spring Water or Bottled Water you can set the hardness level to 3°dH, "extremely soft water".

The machine will give you the following options:

**INACTIVE**, the hardness monitor is turned off. In this case you must use distilled water.

Water Hardness level	Display ... °DH	Equivalent American Grains	Indicator strip number of "reddish" fields
1. extremely soft water	1 to 4	1 to 5	None
2. soft water	5 to 9	6 to 11	1 to 2
3. medium water	10 to 14	12 to 18	2 to 3
4. hard water	15 to 19	19 to 24	3 to 4
5. very hard water	20 to 24	25 to 30	4 to 5
6. extremely hard water	25 to 30	31 & higher	all 5

**Tip:** If your tap water falls into the categories 5 and 6, we recommend using bottled water. **Please note:** If you use the Clearyl Filter with such hard water we recommend decalcifying the machine once or twice a year (chapter 18.3).

## 16.1 CHANGING THE WATER HARDNESS MONITOR

### READY

- Push the rotary dial. **RINSE**.
- Turn the rotary dial until the display shows **HARDNESS**.
- Push the rotary dial. The display shows **10° DH**.

- Turn the rotary dial until desired hardness level is displayed.
- Push the rotary dial to confirm the setting. **OK, HARDNESS**.
- Turn the rotary dial until the display shows **EXIT**.
- Push the rotary dial. The display shows **READY**.

The machine will automatically remind you when it is time to decalcify (chapter 18.3).

## 17. PROGRAMMING / INFORMATION / MAINTENANCE

The J5 provides programming, maintenance and look-up functions. With the display at **READY** you can access these functions as follows:

- Push and hold the Rotary Dial until the display shows **RINSE**.

The J5 offers the following functions (see chart).

- Turn the dial clockwise slowly to scroll through Functions.

**Please note:** to get back to **READY**, turn the Rotary Dial until the display shows **EXIT**, then push the Rotary Dial.

Display	Function/Comment	Chapter
<b>RINSE</b>	Select from RINSE, CLEAN, DE-SCALE to run additional maintenance programs outside the automatic prompts.	17.1
<b>BUTTONS</b>	Change for all six beverage buttons the parameters like cup volume, coffee strength, temperature, steam duration.	17.2
<b>FILTER</b>	Install and activate the CLEARLYL filter. If the filter is installed, the program HARDNESS will not show up	15.1

Display	Function/Comment	Chapter
<b>HARDNESS</b>	Set the water hardness level to the water you are using. The machine will then automatically remind you when it's time to de-scale the machine. If the CLEARYL water filter is installed, this program will not show up.	16.1
<b>ENERGY</b>	You can choose an energy savings mode. The machine will lower the temperature in stand by.	17.3
<b>TIME</b>	Set the time. Once the time is set, you can program an auto-on time (see UNIT-ON).	17.4
<b>UNIT-ON</b>	If the actual time is set, you can program an AUTO-ON time	17.5
<b>OFF AFTER</b>	The machine is set to turn off after 2 hours after last use. You can change this to other intervals.	17.6
<b>INFO</b>	You can check how many cups of coffee you made, total and by beverage button. You can also check the number of tablet cleaning cycles, decalcifying cycles, and Clearyl filters used.	17.7
<b>DISPLAY</b>	You can choose the volume display in metric (ML = milliliters) or in non-metric (OZ = ounces); you can also choose the time format for TIME on UNIT-ON in AM/PM or 24 HRS (military time).	17.8
<b>LANGUAGE</b>	Change the display from English to French, Italian, Dutch (NL) or German.	17.9
<b>EXIT</b>	Push the Rotary button. This brings you back to <b>READY</b> to make coffee again.	

## 17.1 OPTIONAL CLEANING CYCLES

The J5 has built-in maintenance programs which automatically remind you when it is time to perform them. You can also choose to perform these programs outside the programmed cycles. This comes handy if you have not used the machine for a long time or for reasons mentioned below.

To access these maintenance programs outside the built-in cycles, proceed as follows:

### **READY**

- Push and hold the Rotary Dial until the display shows **RINSE**.
- Push the Rotary Dial, the display shows **RINSE**. Turn the dial and the display will show the following options: **CLEAN**,

**DESCALE**, **EXIT**, **RINSE**,

**Please note:** If you do not take action at that time, the display will go back automatically to **READY**.

**Please note:** If the Clearyl Filter is activated, the above sequence will read **RINSE**, **CLEAN**, **FILTER**, **EXIT**.

### **Example for an additional RINSE cycle:**

- Place a cup underneath the coffee spouts. **READY**.
- Push and hold the Rotary Dial until the display shows **RINSE**.
- Push the Rotary Dial, the display shows **RINSE**. Push the rotary dial again. **RINSING**. The machine will run a 15 second hot water rinse cycle and return to **READY**.

### **Example for an additional Tablet Cleaning Cycle:**

See chapter 18.2.

## 17.2 RE-PROGRAMMING ALL BEVERAGE BUTTONS

All six beverage buttons have factory settings (chapter 5). You can override certain settings for just one cup (see chapter 11.1). Overriding does not change the programmed setting for the next use.



You can also program the output visually (chapter 11.2).

You can also re-program all buttons to different values. Re-programming changes the outcome of the beverage permanently. Re-programming is easy. The re-programmed values are stored in the machine's memory until you re-program it again.

Buttons	Parameters	Options
1-cup buttons:	Volume: Strength: Temperature:	0.5 to 8.0 oz. MILD, NORMAL, STRONG, XSTRONG NORMAL, HIGH
2-cup buttons:	Volume: Temperature:	0.5 to 8.0 oz. per cup NORMAL, HIGH
Hot water	Volume: Temperature:	0.5 to 15 oz. REGULAR, NORMAL, HOT
Steam	Duration:	3 to 120 seconds

**Example:** The 1-cup espresso button is set in the factory to **1.5 OZ** volume, strength STRONG and temperature **HIGH**. To re-program the 1-cup espresso button to **2.5 OZ**, **XSTRONG** and temperature **NORMAL** proceed as follows:  
**READY**

1. Push and hold the Rotary Dial until the display shows **RINSE**.
2. Turn the dial clockwise until the display shows **BUTTONS**.
3. Push the rotary dial. The display flashes **SELECT BUTTON**.
4. Push the 1-cup espresso button. The display shows **WATER** (this determines the volume in your cup).

5. Push the rotary dial. The display shows **1.5 OZ**.
6. Turn the dial until the display shows **2.5 OZ**.
7. Push the rotary dial. For two seconds the display shows **OK** and then **WATER** again. You have now changed the coffee volume from 1.5 to 2.5 oz for the 1-cup espresso button.
8. Turn the dial clockwise until the display shows **STRENGTH**.
9. Push the rotary dial. The display shows **STRONG**.
10. Turn the dial until the display shows **XSTRONG**.
11. Push the rotary dial. For two seconds the display shows **OK** and then **STRENGTH** again. You have now changed the coffee strength from **STRONG** to **XSTRONG** for the 1-cup espresso button.
12. Turn the dial clockwise until the display shows **TEMP**.
13. Push the rotary dial. The display shows **HIGH**.
14. Turn the dial until the display shows **NORMAL**.
15. Push the rotary dial. For two seconds the display shows **OK** and then **TEMP** again. You have changed the temperature from **HIGH** to **NORMAL** for the 1-cup espresso button.
16. Turn the dial clockwise until the display shows **EXIT**.
17. Push the rotary dial. The display shows **BUTTONS**.
18. Turn the dial until **EXIT** and push the dial. **READY**.

### 17.3 ENERGY SAVING MODE

The J5 is set to **ENERGY -**. This means the machine is always ready to brew coffee.

You can program an energy savings mode **ENERGY ✓**. The J5 will lower the stand-by temperature. In case you want to brew coffee the machine will then heat up for approx. 30 seconds. To change the energy setting:

## READY,

- Push and hold the Rotary Dial until the display shows **RINSE**.
- Turn the dial clockwise until the display shows **ENERGY –**.
- Push the rotary dial. The display shows **SAVE –**
- Turn the dial until the display shows **SAVE ✓**.
- Push the rotary dial. For two seconds the display shows **OK** and then **ENERGY ✓**.
- Turn the rotary until the display shows **EXIT**.
- Push the rotary dial. **READY**.

## 17.4 SETTING THE TIME

Setting the time lets you set an auto-on time (chapter 17.5).

### READY,

- Push and hold the rotary dial until the display shows **RINSE**.
- Turn the dial clockwise until the display shows **TIME**
- Push the rotary dial. The display shows **--** Turn the dial to set the hour and push the dial to confirm the hour setting.
- Turn the dial to set the minutes and push to confirm For two seconds the display shows **OK** and then **TIME**.
- Turn the rotary until the display shows **EXIT**.
- Push the rotary dial. **READY**.

**Please note:** If you turn the machine off with the main power switch (Fig. 1a) or if you unplug the machine or experience a power outage, the actual time will not be retained. The next time you turn the machine on, the display will first show **TIME --** . Turn the Rotary dial to set the hours, then push the Rotary dial. Turn the Rotary dial again to set the minutes and push to confirm. Now the **AUTO-ON** time will be automatically restored (see next chapter).

## 17.5 SETTING THE AUTO-ON TIME / UNIT ON

You can set a time at which the machine turns itself on. This way you don't have to wait for the machine to warm up. At the programmed time the J5 turns itself on, it will start heating and the display will then show **RINSE**. Just push the Rinse button and within seconds you can brew your first cup of coffee.

**Please note:** Auto-on will only work if you set the actual time and the main power switch is turned on (when the small red light in the On/Off switch is illuminated, you know that the main power is on).

Setting the time allows you to program an auto-on time.

### READY,

- Push and hold the rotary dial until the display shows **RINSE**.
- Turn the dial clockwise until the display shows **UNIT ON**.
- Push the rotary dial. The display shows **--**
- Turn the dial to set the hour and push the dial to confirm the hour setting.
- Turn the dial to set the minutes and push to confirm For two seconds the display shows **OK** and then **UNIT ON**.
- Turn the rotary until the display shows **EXIT**.
- Push the rotary dial. **READY**.

## 17.6 CHANGING THE AUTO-OFF SETTING / OFF AFTER

Your machine is pre-set to turn itself off 2 hours after last use. You can set the Auto-Off from .5 hour to 15 hours or you can set it to **INACTIVE**. In this case the machine will not turn itself off automatically.

### Recommendations:

- If you use the machine only in the morning, leave the auto-off at 2 hours.

- If you use the machine all day change the setting to the largest use interval, e.g. 4 hours. This way the machine is always ready to brew coffee.

#### Changing the AUTO-OFF setting:

**READY,**

- Push and hold the rotary dial until the display shows **RINSE**.
- Turn the dial clockwise until the display shows **AUTO OFF**.
- Push the rotary dial. The display shows **2 HRS**.
- Turn the dial to set desired setting and push the dial to confirm. For two seconds the display shows **OK** and then **AUTO OFF**.
- Turn the rotary until the display shows **EXIT**.
- Push the rotary dial. **READY**.

### 17.7 LOOKING UP INFORMATION

The J5 lets you check...

- how many cups of coffee you made total and individually for each beverage button including the ground coffee funnel,
- how often you used the steam and hot water button,
- how how often you de-scaled the machine,
- how how often you ran a tablet cleaning cycle (CLEAN)
- how how often the filter was changed/activated.

It will also indicate if descaling, tablet cleaning or filter change will be due soon.

**READY.**

- Push and hold the rotary dial until the display shows **RINSE**.
- Turn the dial clockwise until the display shows **INFO**.
- Push the rotary dial. The display shows **BUTTONS**.
- Turn the dial to select from the following sub-programs: **BUTTONS, DE-SCALE, CLEAN, FILTER** (Filter will only come up, if a Clearyl filter is activated), **EXIT**.

**Example:** You would like to know how often the 1-Espresso button was used.

- **INFO**. Turn the dial until the display shows **BUTTONS**.
- Push the dial. The display will show the total number of coffees made, e.g. 36.
- Now push the 1-cup Espresso button. The display will show how often this button was used, e.g. 12.
- Push the dial again. The display shows **BUTTONS**.
- Turn the dial until the display shows **EXIT**.
- Push the button. The display shows **INFO**.
- Turn the dial until the display shows **EXIT** and push the dial. **READY**.

### 17.8 CHANGING THE DISPLAY SETTINGS

This function lets you select the time format AM/PM or 24HRS format and the volume either in ounces OZ or milliliters ML.

**READY.**

- Push and hold the rotary dial until the display shows **RINSE**.
- Turn the dial clockwise until the display shows **DISPLAY**.
- Push the rotary dial. The display shows **ML/OZ**.
- Turn the dial to choose from **24 H / AM PM or ML / OZ or EXIT**.

To change the coffee volume display from OZ to ML, chose **ML / OZ** and push the dial. **OZ**.

- Turn the dial to select **ML** and push to confirm. For two seconds the display shows **OK** and then it shows **ML / OZ**.
- Turn the dial to **EXIT** and push. The the display shows **DIS PLAY**.
- Turn the dial until **EXIT** and push the dial. **READY**.

## 17.9 CHANGING THE LANGUAGE

Your J5 is set to **ENGLISH**. You can the display from English to French (**FRANCAIS**), Italian (**ITALIANO**), Dutch (**NL**) or German (**DEUTSCH**)

### READY

- Push and hold the rotary dial until the display shows **RINSE**.
- Turn the dial clockwise until the display shows **LANGUAGE**.
- Push the rotary dial. The display shows **ENGLISH**.
- Turn the dial to select the desired language (e.g. **ITALIANO**) and push the dial to confirm. For two seconds the display shows **OK** and then it shows **LINGUA** (Italian).
- Turn the rotary until the display shows **EXIT**.
- Push the rotary dial. In this example (Italian) the display now shows **PRONTO** (instead of **READY**).

## 18. AUTOMATIC CLEANING CYCLES

### 18.1 CLEANING WITH SPECIAL TABLET / READY CLEAN

The machine monitors how many coffees are brewed and how often the rinsing program is activated. After approx. 200 coffees or 80 initial rinse cycles the display will show **CLEAN / READY** and the Rinse button is illuminated.

You can continue to make coffee, however we highly recommend cleaning the machine as described below within the next few days. This cleaning program will remove oil build-ups in the brewing chamber. It takes only about 15 minutes. Use the enclosed white cleaning tablet. The machine comes with a pack of 2 tablets. To re-order see chapter 25.

**Important:** Once the cleaning program has started do not interrupt the procedure.

### CLEAN / READY

1. Push the Rinse button. The display shows **EMPTY TRAY**  
**Attention:** If the tray and the used coffee container are already empty, you still need to remove the tray for approx. 20 seconds and then replace it.
2. Make sure that the water container is at least half full. Remove and empty the tray and the used coffee container and replace. The display shows **PRESS RINSE** and the rinse button is illuminated.
3. Place a container (at least 20 oz.) underneath the coffee spouts and push the Rinse button (Fig. 2).
4. The display shows **CLEANING**. The machine pumps one or two short cycles of water through the coffee spout. Then the display shows **ADD TABLET**.
5. Open the ground coffee funnel lid and drop one white tablet into the opening (Fig. 27). Close the lid. The display shows **PRESS RINSE**.
6. Push the rinse button again, and the cleaning program continues. The display shows **CLEANING**. The machine starts the automatic cleaning program by dispensing water in intervals into the container underneath the coffee spout. The program stops automatically and the display shows **EMPTY TRAY**.
7. Remove the container and then the drawer and tray.
8. Empty the drawer and the ground coffee container and replace.
9. The display shows **READY**.  
The machine will automatically remind you after the next 200 cups of coffee to repeat this cycle.

### 18.2 MANUAL TABLET CLEANING CYCLE

It is possible that the brewing process slows down before the automatic message (chapter 18.1) appears. Sometimes dark

beans deposit more oils into the brewing chamber. When this happens you can manually start a tablet cleaning cycle as follows:

#### **READY**

- Push the rotary dial, until the display shows **RINSE**.
- Push the rotary dial again and turn it until the display shows **CLEAN**.
- Push the rotary dial again to confirm that you want to use this program now. The display shows **EMPTY TRAY**.
- Continue with the steps 2 through 9 of chapter 18.1.  
The machine will reset itself and will remind you after the next 200 cups of coffee to repeat this cycle.

### **18.3 DECALCIFINGING / DE-SCALE READY**

The machine has an integrated decalcifying program. This program takes about 40 minutes.

When the display shows **DE-SCALE / READY** it is time to decalcify the machine. The Rinse button is illuminated. You can still make coffee. However, it is highly recommended decalcifying the machine within the next 3 to 4 days.

**Important CLEARYL FILTER:** If you use the Clearyl water cartridge and the display shows **DE-SCALE / READY**, then your cartridge function was not activated. Follow the instructions in chapter 15.1 to activate a new cartridge.

**Important:** The decalcifying program must not be interrupted.

**DECALCIFINGING AGENT:** Only use our special decalcifying tablets Model # 61848, chapter 25.

**CAUTION:** Never use vinegar or any other decalcifying agent. This might damage internal parts of the machine.

**CAUTION:** Immediately remove any splashes or drops of the decalcifying solution from sensitive surfaces, such as natural

stone or wood. Always wait until the decalcifying solution in the water tank has been used up. Do not fill additional decalcifying solution into the water tank.

**DE-SCALE READY** and the Rinse button is illuminated.

1. Push the Rinse button. The display shows **EMPTY TRAY**.

**Attention:** If the tray and the used coffee container are already empty, you still need to remove the tray for approx. 20 seconds and then replace it. **AGENT IN TANK**.

2. Empty the Water Tank. The Clearyl filter should not be in the water tank (see above).
3. Remove the frothXpress or the Dual Frother.
4. Dissolve 3 of the large square decalcifying tablets in a container with 20 oz. of water (0.6 liters) and pour the solution into the water tank.
5. Replace water tank.
6. Place a large container (at least 20 oz.) under the steam nozzle (Fig. 18).
7. Push the rinse button. The display shows **DE-SCALING**. The machine pumps the descaling solution through the system and through the steam nozzle. During this operation, the Rinse button blinks.
8. After approx. 15 minutes the action stops and the display shows **EMPTY TRAY**.
9. Remove the container and then the drawer and tray.
10. Empty the drawer and the ground coffee container. Then replace. **FILL WATER TANK**.
11. Remove the water tank, rinse it thoroughly and fill with up to 18 oz. of fresh cold water and replace. **PRESS RINSE**.
12. Place a large container (at least 20 oz.) under the steam nozzle (Fig. 18) and press the rinse button.

13. The machine pumps the fresh water through the system and through the steam nozzle. During this operation, the Rinse button blinks.
14. When the display shows **EMPTY TRAY**, remove the container and then the drawer and tray.
15. Empty the drawer and the ground coffee container.
16. Replace the Dual Frother or the frothXpress.

#### **HEATING. READY.**

The machine is ready to make coffee again.

The machine will automatically remind you when it's time to decalcify again.

### **18.4 MANUAL DECALCIFYING**

If you use very hard water it is possible that calcium builds up prematurely. If your coffee does not come out as hot as before it is a sign for calcium build-up. When this happens you can manually start a decalcifying cycle as follows:

#### **READY**

- Push the rotary dial, until the display shows **RINSE**.
- Push the rotary dial again and turn it until the display shows **DE-SCALE**.
- Push the rotary dial again to confirm that you want to use this program now. The display shows **EMPTY TRAY**.
- Continue with the steps 2 through 16 of chapter 18.3 above.

The machine will automatically remind you when it's time to decalcify again.

### **19. EMPTYING SYSTEM BEFORE TRANSPORT**

If you transport the machine or if you send it to another place please follow these steps.

- Turn machine off with the On/Off switch (Fig. 2). The on/off button is still illuminated.
- Remove the water tank and empty it and replace.
- Remove the complete drawer, empty all parts, wipe clean and replace all parts.
- Remove beans from the bean container (chapter 20.2). If you transport the machine only for a short distance, secure all lids with a non-abrasive tape.

#### **IMPORTANT / EMPTYING SYSTEM**

To avoid frost damage during transport you must empty the system as follows:

1. Turn machine off with the On/Off switch (Fig. 2). The on/off button is still illuminated.
2. Remove the water tank.
3. Place a cup underneath the steam nozzle.
4. Push and hold the rinse button until the display shows **EMPTYING**. A little bit of water or steam will flow through the steam nozzle. The machine will turn itself off after approx. 30 seconds.
5. Now turn the main power switch off (Fig. 1a) and unplug.

### **20. KEEPING YOUR MACHINE IN TOP SHAPE**

Keeping your Impressa J5 in good working condition will maintain the taste and aroma of your coffee beverages.

- Start the day with fresh, cold water.
- Don't fill more beans into the bean container than you use in two or three days. Store the rest of your beans in a dry dark place. Oxygen, light, heat and moisture diminish the aroma of the coffee bean.
- If you have not used your machine for a few days, brew one

short coffee and discard. The next cup will taste a lot better.

- Always pre-warm your cup with hot water (chapter 10).
- Keep the coffee spouts as close as possible to the cups to maximize crema.

### 20.1 AUTOMATED CLEANING PROGRAMS

The J5 has four automated programs. When it's time the display will remind you to perform those programs.

- Rinsing the machine (e.g. chapter 8)
- Changing the Clearyl filter (chapter 15.2.)
- Cleaning the machine; tablet cleaning cycle to remove coffee oil build-up (chapter 18.1)
- Descaling the machine (chapter 18.3).

### 20.2 CLEANING THE BEAN CONTAINER

Coffee oils might build up inside the bean container. These oils might reduce the taste of your coffee. Too much oil might also hinder the beans from flowing freely into the grinder. Clean the bean container from time to time.

When the display shows **FILL BEANS**, the container is low on beans and easy to clean.

- Turn off the machine by pushing the ON/OFF button (Fig. 2).
- Wait until the machine has shut down completely.
- Turn the main power switch off (Fig 1a).
- Open the bean container lid and remove the bean aroma lid.
- Loosen the screw in the bean container (Fig. 28) and lift the finger protection.
- Remove the remaining beans.
- Clean the bean container with a soft, dry cloth.
- Close the finger protection and tighten the screw and fill with beans.

### 20.3 CLEANING METAL CONTACTS / TRAY MISSING

If you insert the drawer correctly and the display still shows **TRAY MISSING**, remove the drawer and clean and dry the two metal contacts at the end of the drawer. Then insert again.

### 20.4 CLEANING THE INSIDE OF THE MACHINE

- Turn off the machine by pushing the ON/OFF button (Fig. 2).
- Wait until the machine has shut down completely.
- Let cool down for 10 minutes.
- Remove the complete drawer. Wipe the inside of the machine with a paper towel.
- Reach inside the opening and up behind the movable flap . Feel for a round metal surface. You can feel that there is a screw in the middle of this surface. This is the inner screen.
- Take a paper towel and wipe this screen.
- Replace the complete drawer (Fig. 1, parts 8, 9, 10, 11)
- Turn the machine on again with the On/Off button (Fig. 2).

### 20.5 CLEANING THE FROTHXPRESS AND DUAL FROTHER

See chapters 12.1.5, 12.1.6 and 12.2.1.

## 21 DISPLAY MESSAGES

### EMPTY TRAY.

The drawer is full with water. Remove complete drawer and empty all parts.

### EMPTY GROUNDS.

Remove complete drawer and empty all parts.

### TRAY MISSING.

The drawer is not inserted or not inserted correctly. Insert drawer correctly. Clean and dry metal contacts at the end of drawer.

### **FILL BEANS.**

The bean container is (almost) empty. Add beans to the bean container.

### **FILL WATER TANK.**

The water tank is (almost) empty. Add water to the water tank.

### **CLOSE COVER.**

The lid for the ground coffee funnel is open. Close the lid (Fig. 11)

### **NOT ENOUGH PRE-GROUND.**

There is not enough pre-ground coffee in the funnel. See chapter 11.3.

### **TOO HOT.**

The J5 is too hot to perform a cleaning or decalcifying program. Use the hot water button and pump a few ounces of water through the system. Then try again.

### **CLEAN.**

It's time to run a tablet cleaning cycle. See chapter 18.1

### **DE-SCALE.**

It's time to run a decalcifying cycle. See chapter 18.3

## **22. TROUBLESHOOTING**

### **A. COFFEE IS NOT HOT ENOUGH**

See chapter 10.

### **B. MILK IS NOT HOT ENOUGH**

See chapter 12.1.2.

### **C. NO COFFEE COMES OUT OF THE COFFEE SPOUT**

**Reason:** Beans in bean container are not feeding properly into

the grinder because they are stuck together.

**Solution:** Open the bean container safety cover (chapter 20.2) and stir beans.

When using very oily beans pour the beans onto a plate and let some of the sticky oils evaporate (this will not harm the aroma of the coffee).

**Reason:** You used ground coffee in the ground coffee funnel. The ground coffee was too fine.

**Solution:** Use ground coffee which is ground somewhat coarser.

**Reason:** No water is transported through the system.

**Solution 1:** Remove – if installed – the Clearyl water filter. Place a cup underneath the frother and push the Hot Water Button (Fig. 2). If water comes out, try to make coffee again.

**Solution 2:** Remove the water container and make sure that the connecting valve is free of any particles (like a coffee bean). Proceed as under "Solution 1".

**Reason:** The ground coffee funnel is clogged; the internal brewing chamber is clogged.

**Solution:** Place a large cup underneath the coffee spouts and run one or two extra rinse cycles.

### **READY**

- Push and hold the Rotary Button until the display shows **RINSE**.
- Push the Rotary Button again. The display shows **RINSING** and the machine pushes hot water through the coffee spouts and returns to **READY**.
- Repeat if necessary.



## **D. THE DISPLAY READS "FILL WATER" BUT THERE IS ENOUGH WATER IN THE WATER TANK.**

**Reason:** The "low water" floatation device is missing.

**Solution:** Within the water tank is a small compartment (like a mouse trap). Inside is a small black floatation device. On top is a small clear see-through plastic cover. This small plastic cover is missing and the floatation device is outside of the small compartment. Check if you can find both pieces inside the water tank and put it back together. If you cannot find the pieces call **1-800-220-5701**. We will send the pieces **FREE OF CHARGE**.

## **E. INSUFFICIENT FROTHED MILK PRODUCTION**

- If you had sufficient froth initially it is likely that one or more frother parts are not completely clean and that some hardened milk or milk fat prevents the frothing results you had before.
- If you use different kind of milk, it is possible that some milk will produce less froth.
- The frothXpress will always produce more frothing on top of the milk than the Dual Frother.
- The Dual Frother can produce froth with more dense milk bubbles than the frothXpress.

**Solution 1:** Use the frothXpress (chapter 12.1) instead of the Dual Frother.

**Solution 2:** Clean the frothXpress, especially the small venting tip (Fig. 17). Check if the flexible tip is free of any milk residue. When squeezing the flexible part it should open. Make sure all parts of the frothXpress are clean and assembled tightly. Check if any parts of the frothXpress are missing (Fig. 17).

**Solution 3:** Take the Dual Frother apart and make sure that all grooves and holes are free of milk deposits (Fig. 21)

**Solution 4:** Check the steam nozzle (chapter 12.2.2). If any parts are missing call Customer Service 1-800-220-5701.

## **F. GRINDER MAKES AN EXTREMELY LOUD NOISE; NO BEANS ARE GROUND**

**Reason:** A stone or something else is blocking the burr grinder.

**Solution:** See chapter 25.

## **G. THE REMOVABLE DRAWER (Fig.1.11) DOES NOT PULL OUT**

**Reason:** The internal used coffee disposal chute did not retract.

**Solution:**

- Turn off the machine (Fig. 2). Wait a minute. Turn machine on and wait until it stops making any noise.
- Now try to pull out the drawer.
- If this does not work, turn the machine off again and wait a minute.
- Now pull the drawer out with some force. Make sure that the Used Coffee Container (Fig. 1.8) is removed.
- Insert the drawer (without the used coffee container) into the machine. Turn the machine on. Wait until all noise has stopped. The disposable chute should retract. Remove the drawer, replace the used coffee container and insert it back into the machine. Check if the drawer comes out easily.

## **23. ERROR MESSAGES**

The machine can display any of the following error messages:

**ERROR 1, ERROR 3, ERROR 5**

Call our customer service: 1-800-220-5701. Your machine needs to be returned for service.

**ERROR 2, ERROR 4**

Your machine is too cold. The heating sensor does not react. Turn the machine off. Keep the machine at normal room temperature (65° F or higher) for 2 hours. Then turn it on again. If the display still shows **ERROR 2** or **ERROR 4** call customer service.

### **ERROR 6, ERROR 7**

Turn machine off, turn the main power switch off and unplug machine for a minute. Turn machine on again. If the error message comes up again, try one more time. If the message persists, call customer service.

### **ERROR 8**

#### **Reasons:**

1. The used coffee release mechanism got stuck.
2. Drawer was pulled out of the machine during operation.
3. The inner screen of the brew-unit needs to be wiped off.

**Solution 1:** Turn machine off (Fig. 2). Remove the complete drawer. Wait for five minutes. Turn the machine on and wait until a message appears. Insert the complete drawer.

#### **Solution 2:**

- Turn machine off (Fig. 2).
- Remove the complete drawer and wait 10 minutes for the machine to cool down.
- Reach inside the opening. Reach up, behind the movable flap. Your fingers will touch a round metal surface. You can feel that there is a screw in the middle of this surface. This is the inner screen.
- Take a paper towel and wipe this screen. Replace the complete drawer.

- Turn the machine on. First use the hot water cycle, then try to make a cup of coffee. If the message **ERROR 8** still persists call customer service.

## **24. REMOVING STONES FROM THE BURR GRINDER**

Occasionally small stones can be found in between coffee beans. They can block the burr grinder. The grinding noise will become loud and no coffee will be ground.

- Turn off the machine by pushing the ON/OFF button (Fig. 2).
- Wait until the machine has shut down completely.
- Turn the main power switch off (Fig 1a).
- Open the bean container lid and remove the bean aroma lid.
- Loosen the screw in the bean container (Fig. 28) and lift the finger protection.
- Remove the beans.
- Attach the burr grinder release tool (this tool is located in the Welcome Box) to the upper burr (Fig. 30). If you cannot find this tool call 1-800-220-5701 and we will send the tool to you free of charge.
- Turn the tool slowly counter-clockwise until the stone becomes loose and remove the stone.

**Attention:** Do not try to turn the tool clockwise.

Close the finger protection and tighten the screw.

Turn machine on and test the grinder without beans to see if the blockage has disappeared.

## **25. SUPPLIES**

The following supplies are necessary to keep your machine in good working order. You can purchase these supplies:

- from your local Jura-Capresso retailer,

- with the enclosed mail order form,
- through our website [www.capresso.com](http://www.capresso.com) or
- by calling our customer service center at 1-800-220-5701.

#### **Clearyl Water Filter Cartridge** (chapter 16).

One filter included; Model #64553;

The machine will remind you automatically when to replace.

**Tip:** If you brew 10 cups a day you need about one Clearyl cartridge per month. Always keep extra cartridges available.

#### **Special Cleaning Tablets** (chapter 18.1).

Two tablets included; Model #62205;

**Tip:** If you brew 10 cups a day you need about one tablet every 3 weeks. Always keep extra tablets available.

**Tip:** These tablets will also remove coffee and tea discoloration and oil films in other containers (tea kettles, thermal carafes etc.) Fill container with water, add one or two tablets and let stand overnight. Rinse thoroughly).

#### **Auto-Cappuccino Cleaner** (chapter 12.1.6).

One sample bottle with 100 ml included;

250 ml (approx. 8 oz) bottle: Model #63801

**Tip:** If you use the auto cappuccino cleaner once a day you need a new bottle (250ml) every 2 1/2 weeks.

#### **Decalcifying tablets** (chapter 18.3). None included.

Large square tablets - Model #61848

**Please note:** You must use decalcifying tablets if you do not use the Clearyl cartridge.

#### **26. LIMITED TWO YEAR WARRANTY for IMPRESSA J Series**

**Please note:** This warranty will be void if the Warranty / Product Registration has not been received two weeks after the purchase date (you can fax or mail the registration or you can register through our website [www.capresso.com](http://www.capresso.com))

**This limited warranty covers your new IMPRESSA J Series for two years or up to 6,000 coffee brewings, whichever comes first.**

This warranty is in effect for the period and usage described above from the date of the first purchase and is limited to the United States of America. This warranty covers all defects in materials or workmanship (parts and labor) including free UPS ground transportation for both ways within the continental United States. For Hawaii and Alaska freight is not covered by this warranty.

In case the machine cannot be repaired, JURA-CAPRESSO will replace your machine with the same model with the same or less usage. In case we cannot replace your machine with the same model we will replace it with a model of the same or higher retail value with the same or less usage. Usage is defined by the number of coffees the machine has made when sent for repair.

**TRANSPORT:** When sending the machine, use the original packing materials, the inner and outer cartons or use approximately 2" of bubble wrap and insert machine in a carton which will hold 40lbs.

Any damage in transit is NOT covered by this warranty.

#### **THIS WARRANTY DOES NOT COVER:**

- Any machine NOT distributed by JURA-CAPRESSO within the United States.
- Any machine not purchased from an Authorized Jura-

**Capresso Dealer.** (Call our customer service department to check for authorized dealers).

- Any machine purchased through EBAY.
- Damage caused by accident, abuse, negligence, misuse,
- improper operation or failure to follow instructions contained in this manual.
- Any service or alteration performed by an unauthorized person, company or association.
- Damage caused by neglecting and omitting maintenance, cleaning and decalcifying cycles.
- Damage caused by use of instant coffee or any other ingredients not allowed in this product.

**Other limitations and exclusions:**

Any implied warranties including fitness for use and merchant-ability are limited in duration to the period of the express warranty set forth above and no person is authorized to assume for JURA-CAPRESSO any other liability in connection with the sale of the machine. JURA-CAPRESSO expressly disclaims liability for incidental and consequential damages caused by the machine. The terms "incidental damages" refer to the loss of the original purchasers time, loss of the use of the machine or other costs relating to the care and custody of the machine. The terms "consequential damages" refer to the cost of repairing or replacing other property which is damaged when this machine does not work properly. Any loss of income is excluded. The remedies provided under this warranty are exclusive and in lieu of all others. This warranty gives you specific legal rights, and you may also have other rights which vary from state to state.

**27. FREE REPAIR SERVICE / EXTRA REPAIR COVERAGE**

Within the warranty period all repairs are free of charge including both ways UPS ground transportation to and from our service facilities within the continental United States. For Hawaii and Alaska freight is not covered by this warranty.

In case the machine cannot be repaired, JURA-CAPRESSO will replace your machine with the same model with the same or less usage. In case we cannot replace your machine with the same model we will replace it with a model of the same or higher retail value with the same or less usage. Usage is defined by the number of coffees the machine has made when sent for repair. Within four weeks after your product registration you can purchase an extra 12 months of repair coverage. For details see the literature enclosed with this product.

**Jura-Capresso, LLC**

81 Ruckman Road, Closter, NJ 07624

201-767-3999 • Fax: 201-767-9684

Customer Service: 1-800-220-5701

Email: [contact@capresso.com](mailto:contact@capresso.com) • Website: [www.capresso.com](http://www.capresso.com)